

1MSPS 12-bit Analog I/O Board for PCI Express
AIO-163202UG-PE

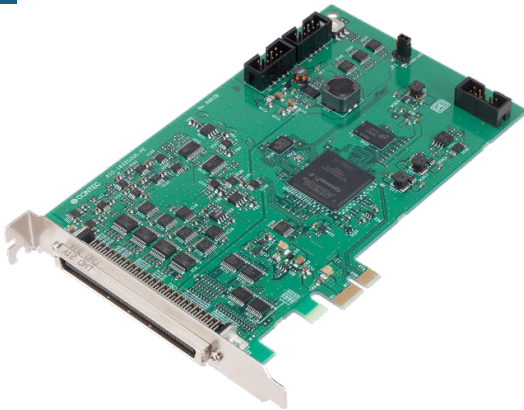

- * The photograph is a AIO-163202UG-PE.
- * Specifications, color and design of the products are subject to change without notice.
- *The contents in this document are subject to change without notice.
- *Visit the CONTEC website to check the latest details in the document.
- *The information in the data sheets is as of July, 2023.

Features

High-performance, multifunction single DAQ device with analog and digital input/output and counter functions

In addition to analog input, this high-performance multi-function device is equipped with 2 analog output channels, 16 digital inputs and outputs, and 2 counter channels (32-bit), enabling measurement control in a compact, reasonably priced package for systems requiring a variety of signal inputs and outputs.

Model	Analog Input			Analog Output		
	Number of channels	Resolution	Conversion speed	Number of channels	Resolution	Conversion speed
AIO-163202UG-PE	Single-Ended: 32ch	16bit	1µsec/ch	2ch	16bit	10µsec
AIO-163202G-PE			10µsec/ch			
AIO-123202UG-PE	Differential: 16ch	12bit	1µsec/ch		12bit	6µsec
AIO-123202G-PE			10µsec/ch			

Adopts and improves on the functions of the Analog E Series with compatibility for the Analog F Series

The Analog G Series was designed as a successor to the best-selling Analog E Series, long recognized as a mainstay of PC-based high-performance analog measurement devices. Using the conversion cable (DT-G2E-16/DT-G2E-32) also makes it possible to use the same connector pin assignments as the Analog E Series, allowing for the use of Analog E Series accessories and user design assets without any modifications.

The Analog G Series also shares the same connector pin assignments as the Analog F Series for use as upward-compatible devices.

This also makes it possible to use Analog F Series accessories and user design assets without any modifications.

DMA bus master transfer function for high-speed, continuous sampling

The DMA bus master transfer function, which allows data to be directly transferred to the PC memory, enables continuous sampling for long periods without affecting the device's maximum conversion speed.

When analog input data is transferred using the bus master transfer function, simultaneous transferring of various data is also possible, including analog output, digital input, digital output, and counter data synchronized with analog input clock signals.

This makes the product ideal for component inspection equipment and measurement testing benches that require high-speed data acquisition over long periods.

The Analog G Series is a PCI Express-compliant data acquisition (DAQ) device with high-speed, high-precision, multi-channel analog input functionality. In addition to analog input, this multi-function device is equipped with analog output, digital input/output, and a counter, enabling measurement control in a compact, reasonably priced package for systems requiring a variety of signal inputs and outputs. The DMA bus master transfer function also enables continuous sampling for long periods without affecting the device's maximum conversion speed. This makes the product ideal for component inspection equipment and measurement testing benches that require high-speed data collection over long periods.

In addition, thanks to the event controller's ability to perform hardware-level integrated management of the trigger, clock, and status of each signal input/output, synchronous signal input/output control—difficult to achieve at the software level—is possible. As a result, the product is ideal for factory automation and mixed-signal testing applications requiring low-latency, real-time responsiveness.

Built-in event controller for advanced synchronization control

The built-in event controller enables integrated management of the triggers and statuses of each signal input and output, enabling hardware-level synchronization control of signal inputs and outputs. As a result, the product is ideal for factory automation and mixed-signal testing applications requiring low-latency, real-time responsiveness.

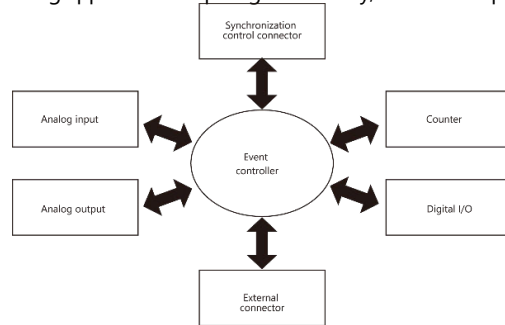

Scenario 1: Analog input and output synchronized with an external clock signal.
 Scenario 2: Analog input performed whenever the counter value reaches the set value.

Synchronized operation of up to 16 devices (connection via synchronization connector)

Synchronized operation of up to 16 devices is possible with no need for external wiring or clock synchronization.

Simply connect the devices via the synchronization connector and a dedicated cable to enable synchronized operation using the event controller. Synchronized operation is also possible with other Contec devices featuring a synchronization connector (such as the DIO-32DM3-PE and CNT-3208M-PE).

Wide selection of wiring accessories and expansion modules with various functions

Choose from a wide selection of expansion modules offering various functions such as buffer amplification (operational amplification), simultaneous sampling (sample/hold amplification), thermocouple input, gain amplification, and low-pass filtering. Various wiring accessories are also available, including BNC terminal blocks, screw terminal blocks, and noise-resistant cables.

Jumper-less, trim-less configuration (software configuration)

Software-based configuration of input range, output range, accuracy calibration, and digital filtering settings is possible while the product is installed on the computer.

- Analog output range settings: $\pm 10V, \pm 5V, \pm 2.5V, 0 - +10V, 0 - +5V, 0 - +2.5V$
- Analog output range settings: $\pm 10V, \pm 5V, \pm 2.5V, \pm 1.25V, 0 - +10V, 0 - +5V, 0 - +2.5V$
- Analog input/output calibration settings: Factory default or user preset
- Digital filtering setting (external trigger/clock, digital input, counter): 0 - 16000 μs

Extensive support software

Device driver for Windows / Linux API-TOOL (Free download)

The API-TOOL device driver/SDK for Windows and Linux, which includes programming API, online help, sample programs, and hardware diagnostic programs, is available to download for free.

Data Logger Software C-LOGGER (Free download)

The Analog G Series is compatible with Contec's C-LOGGER data logger software designed to bring out the best of Contec's analog measurement devices. Take advantage of graphical displays of acquired data, zoomed observation, file saving, and dynamic transferring of data to Excel (spreadsheet software) with no programming required.

DAQfast LabVIEW data acquisition library DAQ-LV-WIN (Free download)

This data recording library makes it possible to use the product with LabVIEW from National Instruments. Polymorphic VIs make using the product simple for LabVIEW users, ensuring the desired operations can be performed quickly and effortlessly.

.NET component collection for DAQfast measurement system development DAQ-DNC-FE (Free download)

This measurement system development support tool is compatible with the Visual Studio integrated development environment. This makes it possible to configure device settings, acquire data, and link data between components with no coding necessary, enabling a highly productive low-code development environment.

Physical Dimensions

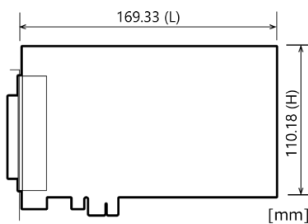

The standard outside dimension (L) is the distance from the end of the card to the outer surface of the slot cover.

Included Items

- Product [AIO-163202G-PE] ...1
- Setup Guide ... 1
- Warranty Certificate ...1
- Serial Number Label ...1
- Sync Signal Cable ...1

Specifications

Function specification

	Item	Description
Analog input	Isolated specification	Un-Isolated
	Input type	Single-Ended Input or Differential Input
	Number of input channels	32ch (Single-Ended Input) 16ch (Differential Input)
	Input range	Bipolar $\pm 10V, \pm 5V, \pm 2.5V$ or Unipolar 0 - +10V, 0 - +5V, 0 - +2.5V
	Absolute max. input voltage *1	$\pm 15V$ (Max.)
	Input impedance	1M Ω or more
	Resolution	16bit
	Non-Linearity error *2*3*4*5	Within $\pm 5LSB$
	Conversion speed	1 $\mu sec/ch$ (Max.)
	Buffer memory	128M Word FIFO or 128M Word RING
	Conversion start trigger	Software, conversion data compare, external trigger, and event controller output.
	Conversion stop trigger	Data save complete, conversion data compare, external trigger, event controller output, and software.
	External start signal *6	LVTTTL level (Rising or falling edge can be selected by software)
External stop signal *6	LVTTTL level (Rising or falling edge can be selected by software)	
External clock signal *6	LVTTTL level (Rising or falling edge can be selected by software)	
External status output signal *7*8	2 LVTTTL level Sampling clock output, etc.	
Analog output	Isolated specification	Un-Isolated
	Number of output channels *8	2ch
	Output range	Bipolar $\pm 10V, \pm 5V, \pm 2.5V, \pm 1.25V$ or Unipolar 0 - +10V, 0 - +5V, 0 - +2.5V
	Output current ability	$\pm 5mA$
	Output impedance	1 Ω or less
	Resolution	16bit
	Non-Linearity error *1	Within $\pm 3LSB$
	Conversion speed	10 μsec (Max.)
	Buffer memory	256k Word FIFO or 256k Word RING
	Conversion start trigger	Software, external trigger, and event controller output.
	Conversion stop trigger	Last sampling count, external trigger, event controller output, and software.
	External start signal *6*8	LVTTTL level (Rising or falling edge can be selected by software)
	External stop signal *6*8	LVTTTL level (Rising or falling edge can be selected by software)
External clock signal *6*8	LVTTTL level (Rising or falling edge can be selected by software)	
External status output signal *7*8	2 LVTTTL level, Sampling clock output, etc.	
Digital I/O section	Number of I/O channels *8*9	16 (The number of inputs and outputs can be set to either 16 inputs, 8 inputs and 8 outputs, or 16 outputs using the software.) *6
	Response time	200nsec (Max.)
	I/O model *6*7	Un-Isolated I/O (LVTTTL level positive logic)
Counter	Number of channels *8	2ch
	Counting system	Up count
	Max. count	FFFFFFFFh (Binary data, 32bit)
	Number of external inputs *6*8	2 LVTTTL level (Gate/Up)/ch, Gate (High level), Up (Rising edge)
	Number of external outputs *7*8	LVTTTL level output/ch, Count match output (positive logic, pulse output)
	Frequency response	10MHz (Max.)
Bus master section	DMA channels	2ch
	Transfer bus width	64/32bit
	Transfer data length	360MByte/s
	FIFO	8k Word/ch
	Scatter/Gather function	2G Byte/ch
Synchronization bus section	Control output signal	Selection of output signal with the software when specifying a sync master product.
	Control input signal	Selection of sync factor with the software when specifying sync slave products.

Item	Description	
Max. product count for connection	16 products including the master product	
Common section	Memory address	Occupies 2 locations 256MByte
	Connector	96-pin half pitch connector [M(male)type] PCR-96LMD [HONDA TSUSHIN KOGYO CO., LTD.] or equivalent
	Current consumption (Max.) *10	3.3V 2500mA, 12V 500mA
	Operating condition	0 - 50°C, 10 - 90%RH (No condensation)
	Bus specification	PCI Express Base Specification Rev.2.0 x1
	Dimension (mm)	169.33(L) x 110.18(H)
	Weight	140g

- *1 Do not input voltages in excess of the maximum input voltage. Similarly, do not input voltage exceeding 1.5 times the range being used, even if less than the maximum input voltage. Inputting too high a voltage may cause a fault.
- *2 The rated precision may not be achieved depending on the cable used.
- *3 The non-linearity error means an error of approximately 0.1% occurs over the maximum range at 0°C and 50°C ambient temperature.
- *4 When using a signal source with a built-in high-speed operational amp.
- *5 Result based on 2 µsec or more when converting multiple channels.
- *6 Inputting a 5 V TTL signal is possible.
- *7 Output to 5V TTL signal is possible. The signal will be output when H is 2.0 V or higher, and L is less than 0.8 V.
- *8 The number of analog outputs, control signals, digital inputs/outputs, counters, etc. will be limited when using a conversion cable (DT-G2E-16 or DT-G2E-32). Refer to the instruction manual of the conversion cable for details.
- *9 When JP1 is set to 2-3, the product will be fixed at 8 inputs and 8 outputs (with 1 output for Simultaneous Hold Output).
- *10 When JP1 is set to 1-2, because there is no external +12 V supply, consumption becomes zero.

Installation Environment Requirements

Item	Description
Operating ambient temperature	0 - +50°C
Operating ambient humidity	10 - 90%RH (No condensation)
Floating dust particles	Not to be excessive
Corrosive gases	None
Standard	VCCI Class A, CE Marking (EMC Directive Class A, RoHS Directive), UKCA

Support Software

You can use CONTEC support software according to your purpose and development environment.

For more details on the supported OS, applicable languages, or to download the latest version of software, visit the CONTEC Web site.

Name	Contents	How to get
Windows version High-efficiency Analog I/O Driver API-AIO(WDM)	The API-AIO(WDM) is the Windows version driver software that provides products in the form of Win32 API functions (DLL). Various sample programs such as Visual Basic and Visual C++, etc and diagnostic program useful for checking operation is provided.	Download from the CONTEC website
Analog I/O Driver for Linux API-AIO(LNX)	This is the Linux version driver software provided in API function formats. The software includes various sample programs such as gcc (C, C++) and Python programs.	Download from the CONTEC website
Data Logger Software C-LOGGER	C-LOGGER is a data logger software program compatible with our analog input products. This program enables the graph display of recorded signal data, zoom observation, file saving, and dynamic transfer to the spreadsheet software "Excel". No troublesome programming is required.	Download from the CONTEC website
LabVIEW VI Library for Data Acquisition DAQ-LV-WIN	This is a data acquisition library to use our devices in the LabVIEW by National Instruments. With Polymorphic VI, our design enables a LabVIEW user to operate seamlessly. Our aim is for the customers to perform easily, promptly what they wish to do.	Download from the CONTEC website
.NET component collection for DAQfast measurement system development DAQ-DNC-FE	A GUI-based measurement system development support tool compatible with the Visual Studio low-code integrated development environment. It contains a collection of components that are very useful for developing applications using Contec's wealth of measurement control devices in the PC-HELPER series (PCIe/PCI, USB, Ethernet) and the industrial IoT CONPROSYS™ nano series.	Download from the CONTEC website

Optional Products

Product Name	Model type	Description
Buffer Amplifier Box for Analog Input Boards	ATBA-32F *1*2	32ch type
	ATBA-16E *3	16ch type
	ATBA-8F *1*2*4	8ch type
Terminal Unit for Relay Terminal Banks	EPD-96 *1	M3.5 x 96P
	EPD-37 *3	M3.5 x 37P
Screw Terminal	EPD-96A *1*5	M3 x 96P
	EPD-37A *3*5	M3 x 37P
	DTP-64A *1	M3 x 96P
	DTP-4C	M2.5 x 37P
General Purpose Terminal	DTP-3C	M3 x 37P
	FTP-15 *6	M3 x 15P
Termination Panel with BNC connectors for Analog I/O Boards	ATP-32F *1	for analog input 32ch
	ATP-16E *3	for analog input 16ch
	ATP-8 *1*4*7	for analog input 8ch
Simultaneous Sample & Hold Accessory for Analog Input	ATSS-16A *3*8	
Isolated Expansion Accessory for Analog Input	ATII-8C *3	
Low Pass Filter Accessory for Analog Input	ATLF-8A *3	
Connection Conversion Shield Cable	DT-G2E-16 *9	16ch (96p → 37p & 15p)
	DT-G2E-32 *9	32ch (96p → 37p x 2 & 15P)
Shielded Cable with One 96-Pin Half-Pitch Connector	PCA96PS-0.5P	0.5m
	PCA96PS-1.5P	1.5m
Shielded Cable with Two 96-Pin Half-Pitch Connectors	PCB96PS-0.5P	0.5m
	PCB96PS-1.5P	1.5m
Shielded Cable with One 37-pin D-type Connector	PCA37PS-0.5P *10	0.5m
	PCA37PS-1.5P *10	1.5m
Shielded Cable with two 37-pin D-type Connectors	PCB37PS-0.5P *10	0.5m
	PCB37PS-1.5P *10	1.5m
Flat Cable with One 96-Pin Half-Pitch Connector	PCA96P-1.5 *11	1.5m
	PCB96P-1.5 *11	1.5m
Flat Cable with a 37-pin D-type Connector	PCA37P-1.5 *10*11	1.5m
	PCB37P-1.5 *10*11	1.5m
Coaxial Cable for Single-ended Inputs	PCC16PS-1.5	1.5m
	PCC16PS-3	3m
2 Wires Shielded Cable for Differential Inputs	PCD8PS-1.5 *10	1.5m
	PCD8PS-3 *11	3m
Shielded Cable with Two 15-pin D-Type Connectors	PCB15PS-1.5P *10	1.5m

- *1 A PCB96PS-* optional cable is required separately. (0.5m is recommended)
- *2 An external power supply is necessary (optional AC adaptor POA200-20-2 prepared)
- *3 A conversion cable (DT-G2E-16 or DT-G2E-32) and a PCB37PS-*P cable are required separately. (0.5m is recommended.)
- *4 The analog input could have 8 channels to be used.
- *5 "Screw upright terminal panel" is used to prevent terminal screws from falling off.
- *6 A conversion cable (DT-G2E-16 or DT-G2E-32) and a PCB15PS-1.5P cable are required separately.
- *7 The digital input can be used up to four points, the digital output up to four points and the counter I/O up to 1 channel.
- *8 An external power supply is necessary.
- *9 A conversion cable (DT-G2E-16 or DT-G2E-32) and a PCB15PS-1.5P cable are required separately. The length of the conversion cable (DT-G2E-16 or DT-G2E-32) is short, therefore, in order to install the FTP-15 securely, we recommend the use of the PCB15PS-1.5P cable.
- *10 A conversion cable (DT-G2E-16 or DT-G2E-32) is required separately.
- *11 Flat cables are not compliant with CE EMC Directive. Use shielded cables to ensure compliance with these standards.
- * Information about the option products, see the Contec's website.

Component Name

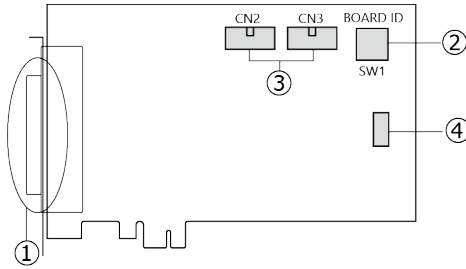

No.	Name	No.	Name
1	Interface Connector	3	Connector for Synchronization control
2	Board ID Setting Switch	4	E Series Setting Jumper (JP1)

Connecting an Interface Connector

To connect an external device to this product, plug the cable from the device into the interface connector (CN1) shown below.

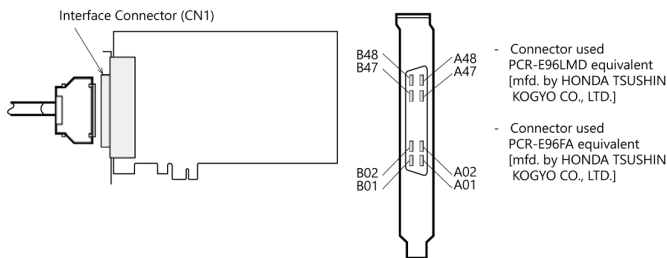

Adding Optional Products

Functions can be expanded by adding various dedicated optional products.

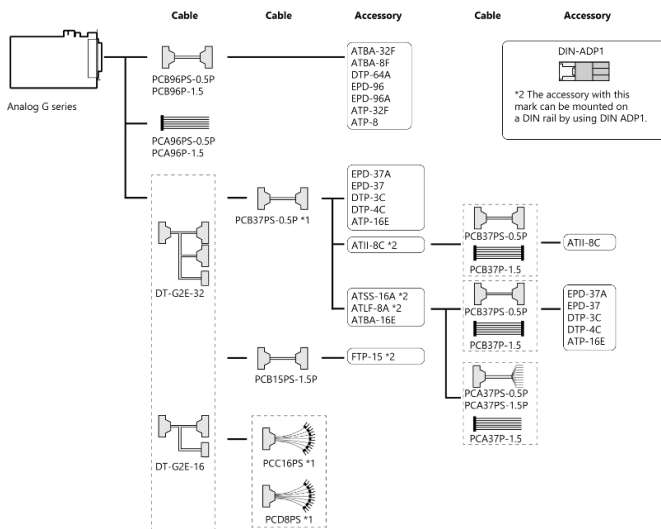

*1 Two sets of cables are necessary to use the DT-G2E-32.
 *2 The optional products with this mark can be mounted on a DIN rail by using [DIN-ADP1] accessory.
 * Please refer to "List of Option" for more information on the supported cable and accessories.

Signal Layout on the Interface Connector (CN1) Single-Ended Input

N.C.	B48	A48	Analog Output 00
N.C.	B47	A47	Analog Ground (for AO)
N.C.	B46	A46	Analog Output 01
N.C.	B45	A45	Analog Ground (for AO)
Analog Input 08	B44	A44	Analog Input 00
Analog Input 24	B43	A43	Analog Input 16
Analog Input 09	B42	A42	Analog Input 01
Analog Input 25	B41	A41	Analog Input 17
Analog Ground (for AI)	B40	A40	Analog Ground (for AI)
Analog Ground (for AI)	B39	A39	Analog Ground (for AI)
Analog Input 10	B38	A38	Analog Input 02
Analog Input 26	B37	A37	Analog Input 18
Analog Input 11	B36	A36	Analog Input 03
Analog Input 27	B35	A35	Analog Input 19
Analog Ground (for AI)	B34	A34	Analog Ground (for AI)
Analog Ground (for AI)	B33	A33	Analog Ground (for AI)
Analog Input 12	B32	A32	Analog Input 04
Analog Input 28	B31	A31	Analog Input 20
Analog Input 13	B30	A30	Analog Input 05
Analog Input 29	B29	A29	Analog Input 21
Analog Ground (for AI)	B28	A28	Analog Ground (for AI)
Analog Ground (for AI)	B27	A27	Analog Ground (for AI)
Analog Input 14	B26	A26	Analog Input 06
Analog Input 30	B25	A25	Analog Input 22
Analog Input 15	B24	A24	Analog Input 07
Analog Input 31	B23	A23	Analog Input 23
Analog Ground (for AI)	B22	A22	Analog Ground (for AI)
Analog Ground (for AI)	B21	A21	Analog Ground (for AI)
Digital Ground	B20	A20	Digital Ground
*1 +5V DC from PC	B19	A19	+5V DC from PC *1
*2 Digital Input/Output 08	B18	A18	Digital Input/Output 00 *3
*2 Digital Input/Output 09	B17	A17	Digital Input/Output 01 *3
*2 Digital Input/Output 10	B16	A16	Digital Input/Output 02 *3
*2 Digital Input/Output 11	B15	A15	Digital Input/Output 03 *3
*2 Digital Input/Output 12	B14	A14	Digital Input/Output 04 *3
*2 Digital Input/Output 13	B13	A13	Digital Input/Output 05 *3
*2 Digital Input/Output 14	B12	A12	Digital Input/Output 06 *3
*2*4 (Simultaneous Hold Output) Digital Input/Output 15	B11	A11	Digital Input/Output 07 *3
AO Control Signal Output 00	B10	A10	AI Control Signal Output 00
AO Control Signal Output 01	B09	A09	AI Control Signal Output 01
Digital Ground	B08	A08	Digital Ground
AO External Sampling Clock Input	B07	A07	AI External Sampling Clock Input
AO External Stop Trigger Input	B06	A06	AI External Stop Trigger Input
AO External Start Trigger Input	B05	A05	AI External Start Trigger Input
Counter UP Clock Input 01	B04	A04	Counter UP Clock Input 00
Reserved	B03	A03	Reserved
Counter Gate Control Input 01	B02	A02	Counter Gate Control Input 00
Control Output 01	B01	A01	Counter Output 00

- The numbers in square brackets [] are pin numbers designated by HONDA TSUSHIN KOGYO CO.

- *1 This becomes enabled when JP1 is set to 2-3.
- *2 Only Digital Output is available when JP1 is set to 2-3.
- *3 Only Digital Input is available when JP1 is set to 2-3.
- *4 Simultaneous Hold Output becomes enabled when JP1 is set to 2-3.

Differential Input

N.C.	B48	A48	Analog Output 00
N.C.	B47	A47	Analog Ground (for AO)
N.C.	B46	A46	Analog Output 01
N.C.	B45	A45	Analog Ground (for AO)
Analog Input 08[+]	B44	A44	Analog Input 00[+]
Analog Input 08[-]	B43	A43	Analog Input 00[-]
Analog Input 09[+]	B42	A42	Analog Input 01[+]
Analog Input 09[-]	B41	A41	Analog Input 01[-]
Analog Ground (for AI)	B40	A40	Analog Ground (for AI)
Analog Ground (for AI)	B39	A39	Analog Ground (for AI)
Analog Input 10[+]	B38	A38	Analog Input 02[+]
Analog Input 10[-]	B37	A37	Analog Input 02[-]
Analog Input 11[+]	B36	A36	Analog Input 03[+]
Analog Input 11[-]	B35	A35	Analog Input 03[-]
Analog Ground (for AI)	B34	A34	Analog Ground (for AI)
Analog Ground (for AI)	B33	A33	Analog Ground (for AI)
Analog Input 12[+]	B32	A32	Analog Input 04[+]
Analog Input 12[-]	B31	A31	Analog Input 04[-]
Analog Input 13[+]	B30	A30	Analog Input 05[+]
Analog Input 13[-]	B29	A29	Analog Input 05[-]
Analog Ground (for AI)	B28	A28	Analog Ground (for AI)
Analog Ground (for AI)	B27	A27	Analog Ground (for AI)
Analog Input 14[+]	B26	A26	Analog Input 06[+]
Analog Input 14[-]	B25	A25	Analog Input 06[-]
Analog Input 15[+]	B24	A24	Analog Input 07[+]
Analog Input 15[-]	B23	A23	Analog Input 07[-]
Analog Ground (for AI)	B22	A22	Analog Ground (for AI)
Analog Ground (for AI)	B21	A21	Analog Ground (for AI)
Digital Ground	B20	A20	Digital Ground
*1 +5V DC from PC	B19	A19	+5V DC from PC *1
*2 Digital Input/Output 08	B18	A18	Digital Input/Output 00 *3
*2 Digital Input/Output 09	B17	A17	Digital Input/Output 01 *3
*2 Digital Input/Output 10	B16	A16	Digital Input/Output 02 *3
*2 Digital Input/Output 11	B15	A15	Digital Input/Output 03 *3
*2 Digital Input/Output 12	B14	A14	Digital Input/Output 04 *3
*2 Digital Input/Output 13	B13	A13	Digital Input/Output 05 *3
*2 Digital Input/Output 14	B12	A12	Digital Input/Output 06 *3
*2*4 (Simultaneous Hold Output) Digital Input/Output 15	B11	A11	Digital Input/Output 07 *3
AO Control Signal Output 00	B10	A10	AI Control Signal Output 00
AO Control Signal Output 01	B09	A09	AI Control Signal Output 01
Digital Ground	B08	A08	Digital Ground
AO External Sampling Clock Input	B07	A07	AI External Sampling Clock Input
AO External Stop Trigger Input	B06	A06	AI External Stop Trigger Input
AO External Start Trigger Input	B05	A05	AI External Start Trigger Input
Counter UP Clock Input 01	B04	A04	Counter UP Clock Input 00
Reserved	B03	A03	Reserved
Counter Gate Control Input 01	B02	A02	Counter Gate Control Input 00
Counter Output 01	B01	A01	Counter Output 00

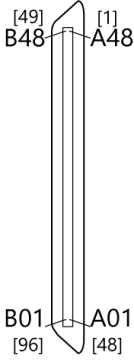

- The numbers in square brackets [] are pin numbers designated by HONDA TSUSHIN KOGYO CO.
- *1 This becomes enabled when JP1 is set to 2-3.
- *2 Only Digital Output is available when JP1 is set to 2-3.
- *3 Only Digital Input is available when JP1 is set to 2-3.
- *4 Simultaneous Hold Output becomes enabled when JP1 is set to 2-3.

Signal name	Description
Analog Input00 - Analog Input31	Analog input signal with single-ended input. The numbers correspond to channel numbers.
Analog Input 0[+] - Analog Input 15[+]	Analog input signal with differential input. The numbers correspond to channel numbers.
Analog Input 0[-] - Analog Input 15[-]	Analog input signal with differential input. The numbers correspond to channel numbers.
Analog Output00 - Analog Output01	Analog output signal. The numbers correspond to channel numbers.
Analog Ground	Common analog ground for analog I/O signals.
AI External Start Trigger Input	External trigger input for starting analog input sampling.
AI External Stop Trigger Input	External trigger input for stopping analog input sampling.
AI External Sampling Clock Input	External sampling clock input for analog input.
AI Control Signal Output 00	External sampling clock output signal for analog input.
AI Control Signal Output 01	External output signal for analog input status. Not currently connected.
AO External Start Trigger Input	External trigger input for starting analog output sampling.
AO External Stop Trigger Input	External trigger input for stopping analog output sampling.
AO External Sampling Clock Input	External sampling clock input for analog output.
AO Control Signal Output 00	External sampling clock output signal for analog output.
AO Control Signal Output 01	External output signal for analog output status. Not currently connected.
Digital Input/Output 00 - Digital Input/Output 15	Digital I/O signal.
Counter Gate Control Input00 - Counter Gate Control Input01	Gate control input signal for counter.
Counter Up Clock Input00 - Counter Up Clock Input01	Count-up clock input signal for counter.
Counter Output00 - Counter Output01	Count match output signal for counter.
Digital Ground	Common digital ground for digital I/O signals, external trigger inputs, external sampling clock inputs, and counter I/O signals.
+5V DC from PC	Outputs +5V. The total current-carrying capacity that can be supplied is 0.9. Mainly used for supplying power to expansion accessories.
Simultaneous Hold Output	Control signal for simultaneous sampling unit ATSS-16A available as an option.
Reserved	Reserved pin
N.C.	No connection to this pin

CAUTION

- Do not connect any of the outputs and power outputs to the analog or digital ground. Neither connect outputs to each other. Doing either can result in a fault.
- If analog and digital ground are shorted together, noise on the digital signals may affect the analog signals. Accordingly, analog and digital ground should be separated.
- Leave "Reserved" pins unconnected. Connecting these pins may cause a fault in the product.

Connecting Analog Input Signal

Single-ended Input

Single-ended Input Connection (Flat Cable)

The following figure shows an example of flat cable connection. Each signal source is connected to one analog input channel and the signal common to analog ground pin of CN1.

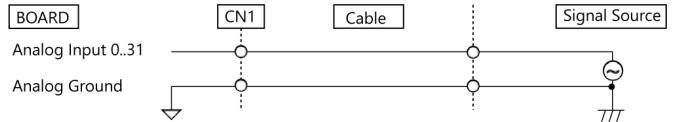

Single-ended Input Connection (Shielded Cable)

The following figure shows an example of shielded cable connection. When the distance between the signal source and the product is long or you want to increase the noise tolerance, a shield cable is suggested. Connect the signal by the core wire and common signal by the shield braids.

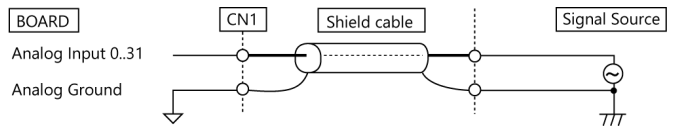

CAUTION

- When a frequency of 1MHz or higher is contained in the source signal, the cross talk between channels may occur.
- If the product and the signal source receive noise or the distance between the product and the signal source is too long, data may not be input properly.
- An input analog signal should not exceed the maximum input voltage (relate to the product analog ground). If it exceeds the maximum voltage, the product may be damaged.
- Connect all the unused analog input channels to analog ground.
- In the channel switching, the multiplexer does the electrical charge and discharge on the internal capacitor according to the signal voltage. Therefore, the voltage from the previous switching state may go into the next channel. It might cause the error of the signal source action. If this occurs, insert a high-speed amplifier as a buffer between the signal source and the analog input pin to reduce the fluctuation.
- An input pin may fail to obtain input data normally when the signal source connected to the pin has high impedance. If this is the case, change the signal source to one with lower output impedance or insert a high-speed amplifier buffer between the signal source and the analog input pin to reduce the effect.

Differential Input

Differential Input Connection (Flat Cable)

The following figure shows an example of flat cable connection. Each signal source is connected to a [+] pin of analog input channel and the signal common of this source to the [-] pin of this input channel of CN1. In addition, the signal common must be connected to the pin of the analog ground of CN1 by a third wire.

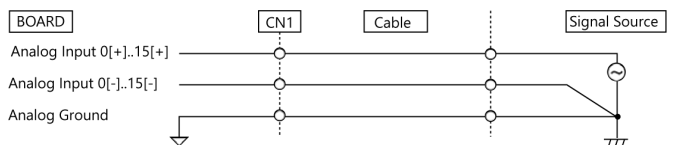

Differential Input Connection (Shielded Cable)

The following figure shows an example of shielded cable connection. When the distance between the signal source and the product is long or you want to increase the noise tolerance, a shield cable connection is preferred. Each signal source is connected to a [+] pin of analog input channel and the signal common of this source to the [-] pin of this input channel of CN1. In addition, the signal common must be connected to the pin of the analog ground of CN1 by the shielded braids.

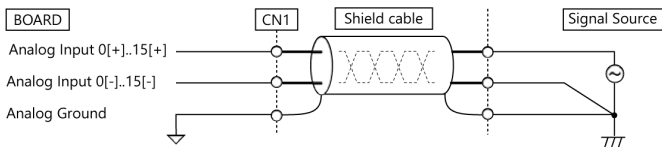

▼CAUTION

- When a frequency of 1MHz or higher is contained in the source signal, the cross talk between channels may occur.
- The input data would be uncertain if the analog ground is not connected.
- If the product and the signal source receive noise or the distance between the product and the signal source is too long, data may not be input properly.
- The input voltage from the [+] input or [-] input should not exceed the maximum input voltage (based on the product analog ground). If it exceeds the maximum voltage, the product may be damaged.
- Because the input data will be uncertain if the [+] pin or the [-] pin of CN1 is not connected, all the unused input pins of CN1 should be connected to the analog ground, AGND.
- In the channel switching, the multiplexer does the electrical charge and discharge on the internal capacitor according to the signal voltage. Therefore, the voltage from the previous switching state may go into the next channel. It might cause the error of the signal source action. If this occurs, insert a high-speed amplifier as a buffer between the signal source and the analog input pin to reduce the fluctuation.
- An input pin may fail to obtain input data normally when the signal source connected to the pin has high impedance. If this is the case, change the signal source to one with lower output impedance or insert a high-speed amplifier buffer between the signal source and the analog input pin to reduce the effect.

Analog Output Signal Connection

Analog Output Connection (Flat Cable)

The following figure shows an example of flat cable connection. Connect the signal source and ground to the CN1 analog output.

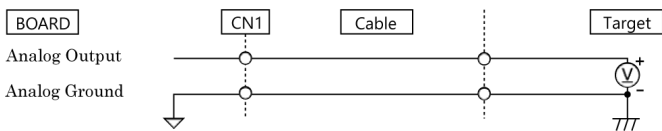

Analog Output Connection (Shielded Cable)

The following figure shows an example of shielded cable connection. Use shielded cable if the distance between the signal source and product is long or if you want to provide better protection from noise. For the CN1 analog output, connect the core wire to the signal line and connect the shielding to ground.

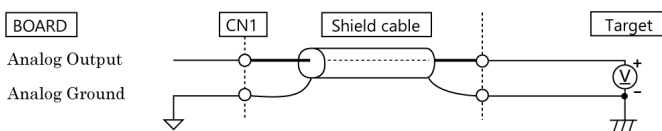

▼CAUTION

- If the product or the connected wire receives noise, or the distance between the product and the target is long, data may not be outputted properly.
- For analog output signal, the current capacity is ±5mA (Max). Check the specification of the connected device before connecting the product.
- Do not short the analog output signal to analog ground, digital ground, and/or power line. Doing so may damage the product.
- Do not connect an analog output signal to any other analog output, either on the product or on an external device, as this may cause a fault on the product.

Connecting I/O Signals

The following sections show examples of how to connect digital I/O signals.

All the I/O signals are TTL level, and input or output can be set in 8-bit units by software.

Digital I/O Circuit

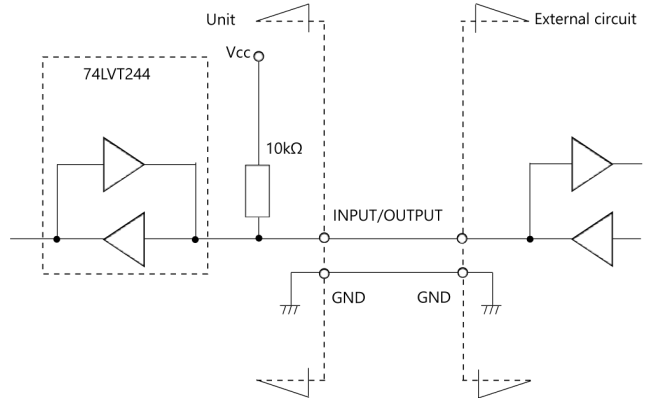

Example of Connection

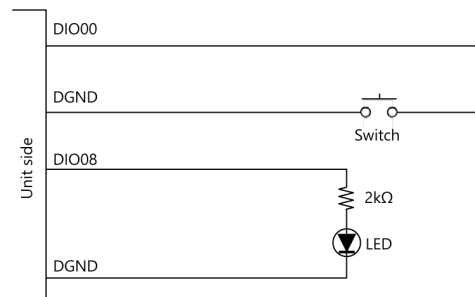

When switch is "ON", the corresponding bit is "0". When switch is "OFF" in contrast, the corresponding bit is "1". When "1" is output to a relevant bit, the corresponding LED comes on. When "0" is output to the bit, in contrast, the LED goes out.

These input/output signals are changed according to the software configuration when JP1 is set to 1-2. When JP1 is set to 2-3, the product will be fixed at 8 inputs and 8 outputs (with 1 output for Simultaneous Hold Output).

▼CAUTION

- Do not short the outputs to analog or digital ground. In addition, do not connect two outputs together. Doing either can result in a fault.
- If JP1 is set to 1-2 when the product power is turned on, only inputs will be used.
- When JP1 is set to 2-3, the product will be fixed at 8 inputs and 8 outputs (with 1 output for Simultaneous Hold Output).

Counter signals and Control signals Connection

The following sections show examples of how to connect counter I/O signals, and other control I/O signals (external trigger input signals, sampling clock input signals, etc.). All the counter signals and control signals are LVTTTL.

Counter input and Control input Connection

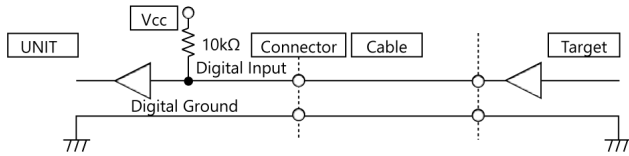

Counter output and Control output Connection

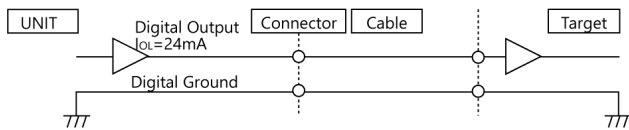

About the counter input control signal

Counter Gate Control Input (refer to the chapter 3 Connector Pin Assignment) acts as an input that validate or invalidate the input of an external clock for the counter. This function enables the control of an external clock input for the counter. The external clock for the counter is effective when input is "High" and invalid when input is "Low". If unconnected, it is a pull-up in this product and remains "High". Therefore the external clock for the counter is effective when the counter gate control input is not connected.

CAUTION

- Do not short the output signals to analog ground, digital ground, and/or power line. Doing so may damage the product.
- If connected to each output, a pull-up resistor must be about 10kΩ to pull up with a 5V power source. Each input accepts 5V TTL signals.

Block Diagram

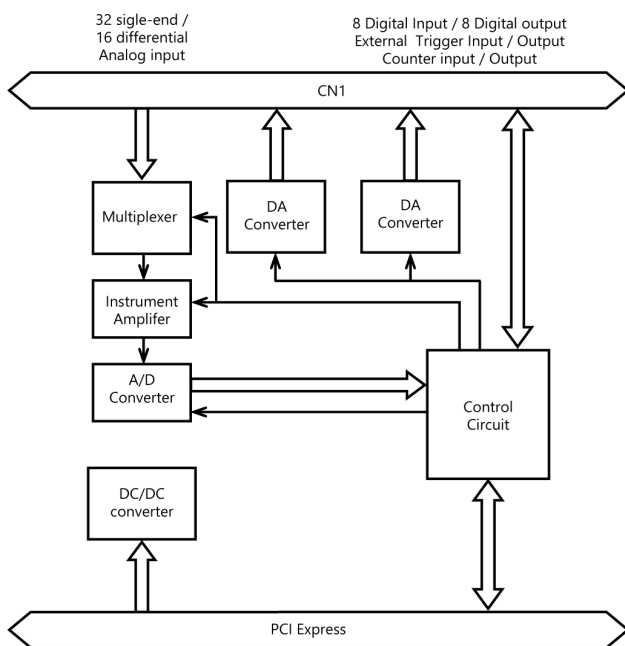

Differences between this product and our earlier models.

AIO-163202UG-PE and F-series

Item	AIO-163202UG-PE *1	AIO-163202F-PE	ADA16-32/(PCI)F
Analog Input Conversion speed	1μsec/ch(Max)	2μsec/ch(Max)	2μsec/ch(Max)
Analog Input Buffer memory	128M Word FIFO or 128M Word RING	64k Word FIFO or 64k Word RING	64k Word FIFO or 64k Word RING
Analog Input Control signal Signal Level	LVTTTL level *2	LVTTTL level *2	TTL level
Analog Input External status output Signal Level	LVTTTL level *3	LVTTTL level *3	TTL level
Analog Input External status output IoL	24mA	8mA	24mA
Analog Output Buffer memory	256k Word FIFO or 256k Word RING	64k Word FIFO or 64k Word RING	64k Word FIFO or 64k Word RING
Analog Output Control signal	LVTTTL level *2	LVTTTL level *2	TTL level
Analog Output External status output Signal Level	LVTTTL level *3	LVTTTL level *3	TTL level
Analog Output External status output IoL	24mA	8mA	24mA
Digital input	LVTTTL level 16, 8, 0ch *2*4	LVTTTL level 8ch *2	TTL level 8ch
Digital output	LVTTTL level 0, 8, 16ch *3*4	LVTTTL level 8ch *3	TTL level 8ch
Digital output IoL	24mA	8mA	24mA
Counter External Input Input Level	LVTTTL level *2	LVTTTL level *3	TTL level
Counter External output Output Level	LVTTTL level *3	LVTTTL level *3	TTL level
Counter External Output IoL	24mA	8mA	24mA
Bus master Transfer data length	360MByte/s	80MByte/s	80MByte/s
Bus master FIFO	8K Word/ch	1K Word/ch	1K Word/ch
Bus master Scatter/Gather function	2G Byte/ch	64M Byte/ch	64M Byte/ch
Occupied address	Memory address 256Mbyte x 2	I/O address 64 ports x 1, 256 ports x 1	I/O address 64 ports x 1, 256 ports x 1
Bus specification	PCI Express Base Specification Rev.2.0 x1	PCI Express Base Specification Rev. 1.0a x1	PCI (32bit, 33MHz, Universal key shapes supported)
External supply capable current	3.3VDC 2500mA 12VDC 500mA *5	3.3VDC 500mA 12VDC 300mA	5VDC 1100mA
Dimension (mm)	169.33(L) x 110.18(H)	169.33(L) x 110.18(H)	176.41(L) x 105.68(H)
Weight	140g	140g	130g

*1 When JP1 is set to 1-2.
 *2 Inputting a 5V TTL signal is possible.
 *3 Output to 5V TTL signal is possible. The signal will be output when H is 2.0V or higher, and L is less than 0.8V.
 *4 The number of inputs and outputs can be set to either 16 inputs, 8 inputs and 8 outputs, or 16 outputs using the software.
 *5 When JP1 is set to 1-2, because there is no external +5V supply, the 12V consumption becomes zero.

AIO-163202UG-PE and E-series

Item	AIO-163202UG-PE *1	AIO-163202F-PE	ADA16-32/2(PCI)F
Analog input Number of channels	32ch (Single-Ended Input), 16ch (Differential Input) *2	16ch (Single-Ended Input), 8ch (Differential Input)	16ch (Single-Ended Input), 8ch (Differential Input)
Analog input Input range	Bipolar ±10V, ±5V, ±2.5V or Unipolar 0 - +10V, 0 - +5V, 0 - +2.5V	Bipolar ±10V, ±5V or Unipolar 0 - +10V, 0 - +5V	Bipolar ±10V, ±5V or Unipolar 0 - +10V, 0 - +5V
Analog input Range setting	Software	Jumper	Jumper
Analog input Buffer memory	128M Word FIFO or 128M Word RING	32M Word FIFO or 32M Word RING (16M data) *3	32M Word FIFO or 32M Word RING (16M data) *3
Analog input Control signal	LVTTTL level 3ch *4	LVTTTL level 3ch	TTL level 3ch
Analog input External status output	LVTTTL level 2ch *5*6	TTL level 1ch	TTL level 1ch
Analog output Number of channels	2ch *6	1ch	1ch
Analog output range	Bipolar ±10V, ±5V, ±2.5V, ±1.25V or Unipolar 0 - +10V, 0 - +5V, 0 - +2.5V	Bipolar ±10V or Unipolar 0 - +10V	Bipolar ±10V or Unipolar 0 - +10V
Analog output Range setting	Software	Jumper	Jumper
Analog output Buffer memory	256k Word FIFO or 256k Word RING	---	---
Analog output Conversion start trigger	Software, conversion data compare, external trigger *6, and event controller output.	---	---
Analog output Conversion stop trigger	Data save complete, conversion data compare, external trigger *6, event controller output, and software.	---	---
Analog output Control signal	LVTTTL level 3ch *4*6	---	---
Analog output External status output	LVTTTL level 2ch *5*6	---	---
Digital input	LVTTTL level 8ch *4*6	TTL level 4ch	TTL level 4ch
Digital output	LVTTTL level 8ch *5*6	TTL level 4ch	TTL level 4ch
Counter channel	2ch *6	1ch	1ch
Counter Device	--- *7	i8254 equivalent	i8254 equivalent
Counter Clock	Internal signal (10MHz) or External Signal	Internal signal (4MHz) or External Signal	Internal signal (4MHz) or External Signal
Max. count	FFFFFFFFh (Binary data, 32bit)	FFFFFFFFFFFFh (Binary data, 48bit) *8	FFFFFFFFFFFFh (Binary data, 48bit) *8
Counter Number of Channels	2ch *6	1ch	1ch
Counter External Input Input level	LVTTTL level *4	LVTTTL level *2	TTL level
Counter External Output Output level	LVTTTL level *5	LVTTTL level *3	TTL level
Bus master	Installed	---	---
Synchronization bus	Installed	---	---
Occupied address	Memory address 256Mbyte x 2	I/O address 32 ports	I/O address 32 ports
Connector	96-pin half pitch connector [M(male)type] PCR-96LMD [HONDA TSUSHIN KOGYO CO., LTD.] or equivalent *9	37 pin D-SUB connector [F (female) type] Screw lock #4-40UNC DCLC-J37SAF-20L9E [mfd. by JAE] equivalent to it 16-pin Pin-header PS-16SEN-D4P1-1C [mfd. by JAE] equivalent to it	37 pin D-SUB connector [F (female) type] Screw lock #4-40UNC DCLC-J37SAF-20L9E [mfd. by JAE] equivalent to it 16-pin Pin-header PS-16SEN-D4P1-1C [mfd. by JAE] equivalent to it
Current consumption	3.3VDC 2500mA 12VDC 500mA *10	3.3VDC 2000mA *11	5VDC 1100mA *11
Bus specification	PCI Express Base Specification Rev.2.0 x1	PCI Express Base Specification Rev. 1.0a x1	PCI (32bit, 33MHz, Universal key shapes supported)
Dimension (mm)	169.33(L) x 110.18(H)	169.33(L) x 110.18(H)	176.41(L) x 105.68(H)
Weight	140g	160g	150g

- *5 Output to 5V TTL signal is possible. The signal will be output when H is 2.0 V or higher, and L is less than 0.8 V.
- *6 The number of analog outputs, control signals, digital inputs/outputs, counters, etc. will be limited when using a conversion cable (DT-G2E-16 or DT-G2E-32). Refer to the instruction manual of the conversion cable for details.
- *7 A separate counter function is installed.
- *8 It is the case above listed according to the setting of the installed jumper. It could be 32bit depending on the settings.
- *9 Conversion to a connector equivalent to the AIO-161601UE3-PE or AD16-16U(PCI)EV is possible by using a conversion cable.
- *10 The 12 V consumption becomes zero when no external +5 V supply is used.
- *11 The current consumption increases when +5 V is supplied externally from the connector.

*1 When JP1 is set to 2-3.
 *2 When using the DT-G2E-16, either 16 channels (single-ended input) or 8 channels (differential input) will be used.
 *3 1 data bit = 2 words
 *4 Inputting a 5 V TTL signal is possible.